

Pružiny do nástrojov a foriem podľa DIN 10243 – NP-R

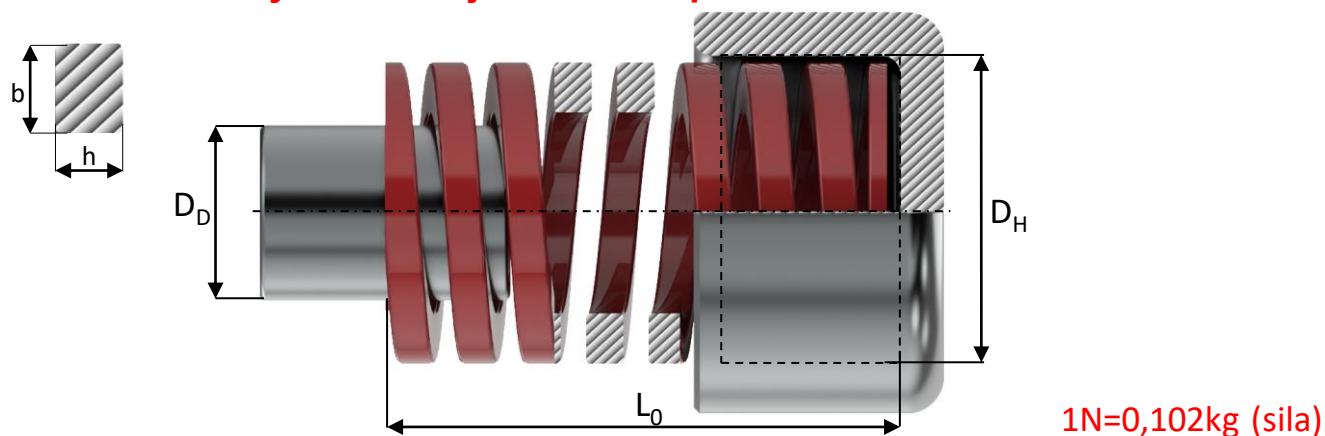

KATALÓGOVÉ ČÍSLO	D _H D _D		L ₀	Tuhosť k	20%		25%		30% Max. dovolené stlačenie		D Max. stlačenie		
	bxh				mm	N/mm	mm	N	mm	N		mm	N
	mm	mm											
R 10 - 025	10	5	25	22.1	5.0	111	6.3	139	7.5	166	9.2	203	
R 10 - 032			32	17.5	6.4	112	8.0	140	9.6	168	12.1	212	
R 10 - 038			38	17.1	7.6	130	9.5	162	11.4	195	13.2	226	
R 10 - 044			44	15.0	8.8	132	11.0	165	13.2	198	15.1	227	
R 10 - 051			51	12.8	10.2	131	12.8	164	15.3	196	19.5	250	
R 10 - 064			64	10.7	12.8	137	16.0	171	19.2	205	21.8	233	
R 10 - 076			76	7.5	15.2	114	19.0	143	22.8	171	27.9	209	
R 10 - 305			1.9x1.5		305	2.1	61.0	128	76.3	160	91.5	192	127.2
R 13 - 025	12.5	6.3	25	42.1	5.0	211	6.3	265	7.5	316	9.8	413	
R 13 - 032			32	33.2	6.4	212	8.0	266	9.6	319	13.6	452	
R 13 - 038			38	29.3	7.6	223	9.5	278	11.4	334	14.6	428	
R 13 - 044			44	24.6	8.8	216	11.0	271	13.2	325	18.1	445	
R 13 - 051			51	19.6	10.2	200	12.8	251	15.3	300	22.3	437	
R 13 - 064			64	15.0	12.8	192	16.0	240	19.2	288	27.3	410	
R 13 - 076			76	13.2	15.2	201	19.0	251	22.8	301	33.1	437	
R 13 - 089			89	11.4	17.8	203	22.3	254	26.7	304	38.9	443	
R 13 - 102	102	8.4	20.4	171	25.5	214	30.6	257	43.8	368			
R 13 - 305	2.4x1.9		305	2.8	61.0	171	76.3	214	91.5	256	139.7	391	
R 16 - 025	16	8	25	75.7	5.0	379	6.3	477	7.5	568	8.4	636	
R 16 - 032			32	52.8	6.4	338	8.0	422	9.6	507	10.5	554	
R 16 - 038			38	48.5	7.6	369	9.5	461	11.4	553	13.6	660	
R 16 - 044			44	42.8	8.8	377	11.0	471	13.2	565	15.9	681	
R 16 - 051			51	37.1	10.2	378	12.8	475	15.3	568	18.9	701	
R 16 - 064			64	30.3	12.8	388	16.0	485	19.2	582	24.9	754	
R 16 - 076			76	25.7	15.2	391	19.0	488	22.8	586	29.2	750	
R 16 - 089			89	21.7	17.8	386	22.3	484	26.7	579	34.5	749	
R 16 - 102	102	19.3	20.4	394	25.5	492	30.6	591	39.1	755			
R 16 - 115	115	15.7	23.0	361	28.8	452	34.5	542	44.0	691			
R 16 - 305	3.1x2.5		305	7.1	61.0	433	76.3	542	91.5	650	103.6	736	



PRODUKT GROUP s.r.o.

Jánošíkova 560

906 32 Jablonica

IČO: 47723254

DIČ: 2024064031

IČ DPH: SK2024064031

+421 910 397 780

+421 34 65 83 401



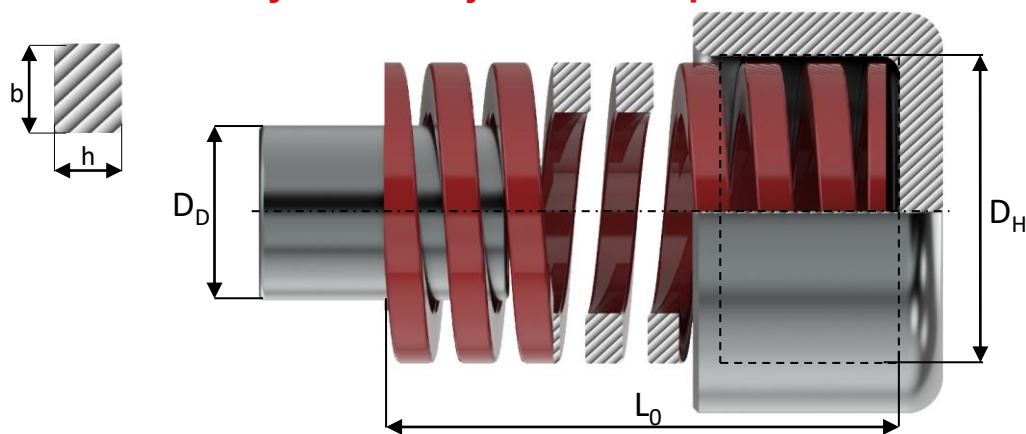

info@pruziny.com

www.pruziny.com

Pružiny do nástrojov a foriem podľa DIN 10243 – NP-R

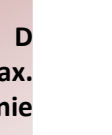

1N=0,102kg (sila)

KATALÓGOVÉ ČÍSLO	D _H D _D		L ₀	Tuhosť k	20%		25%		30% Max. dovolené stlačenie			D Max. stlačenie
	bxh											
	mm	mm								mm		
R 20 - 025	20	10	25	216	5.0	1080	6.3	1361	7.5	1620	8.3	1793
R 20 - 032			32	168	6.4	1075	8.0	1344	9.6	1613	10.9	1831
R 20 - 038			38	129	7.6	980	9.5	1226	11.4	1471	12.5	1613
R 20 - 044			44	112	8.8	986	11.0	1232	13.2	1478	15.0	1680
R 20 - 051			51	94.0	10.2	959	12.8	1203	15.3	1438	17.6	1654
R 20 - 064			64	72.1	12.8	923	16.0	1154	19.2	1384	22.6	1629
R 20 - 076			76	59.7	15.2	907	19.0	1134	22.8	1361	27.5	1642
R 20 - 089			89	50.5	17.8	899	22.3	1126	26.7	1348	31.7	1601
R 20 - 102			102	44.2	20.4	902	25.5	1127	30.6	1353	37.5	1658
R 20 - 115			115	38.4	23.0	883	28.8	1106	34.5	1325	42.6	1636
R 20 - 127			127	34.1	25.4	866	31.8	1084	38.1	1299	45.5	1552
R 20 - 139			139	31.0	28.0	868	35.0	1085	42.0	1302	50.1	1553
R 20 - 152			152	28.2	30.4	857	38.0	1072	45.6	1286	55.8	1574
R 20 - 305			4.0x3.3	305	15.0	61.0	915	76.3	1145	91.5	1373	114.1
R 25 - 025	25	12x5	25	375	5.0	1875	6.3	2363	7.5	2813	8.5	3188
R 25 - 032			32	297	6.4	1901	8.0	2376	9.6	2851	11.0	3267
R 25 - 038			38	219	7.6	1664	9.5	2081	11.4	2497	12.6	2759
R 25 - 044			44	187	8.8	1646	11.0	2057	13.2	2468	14.8	2768
R 25 - 051			51	156	10.2	1591	12.8	1997	15.3	2387	17.9	2792
R 25 - 064			64	123	12.8	1574	16.0	1968	19.2	2362	23.1	2841
R 25 - 076			76	99.0	15.2	1505	19.0	1881	22.8	2257	26.3	2604
R 25 - 089			89	84.0	17.8	1495	22.3	1873	26.7	2243	30.5	2562
R 25 - 102			102	73.0	20.4	1489	25.5	1862	30.6	2234	37.3	2723
R 25 - 115			115	65.0	23.0	1495	28.8	1872	34.5	2243	41.9	2724
R 25 - 127			127	57.7	25.4	1466	31.8	1835	38.1	2198	46.2	2666
R 25 - 139			139	52.7	28.0	1476	35.0	1845	42.0	2213	49.3	2598
R 25 - 152			152	47.8	30.4	1453	38.0	1816	45.6	2180	55.7	2662
R 25 - 178			178	41.0	35.6	1460	44.5	1825	53.4	2189	65.1	2669
R 25 - 203	203	35.8	40.6	1453	50.8	1819	60.9	2180	74.5	2667		
R 25 - 305	5.5x4.2	305	22.9	61.0	1397	76.3	1747	91.5	2095	110.2	2524	



PRODUKT GROUP s.r.o.

Jánošíkova 560

906 32 Jablonica

IČO: 47723254

DIČ: 2024064031

IČ DPH: SK2024064031

+421 910 397 780

+421 34 65 83 401



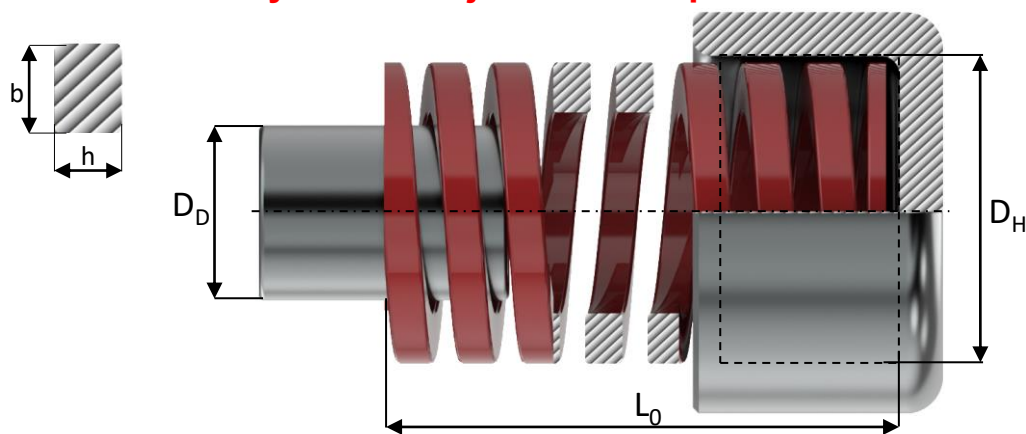

info@pruziny.com

www.pruziny.com

Pružiny do nástrojov a foriem podľa DIN 10243 – NP-R



1N=0,102kg (sila)

KATALÓGOVÉ ČÍSLO	D _H	D _D	L ₀	Tuhosť k	20%		25%		30% Max. dovolené stlačenie			D Max. stlačenie	
	bxh												
	mm	mm			mm	N/mm	mm	N	mm	N			mm
R 32 - 038	32	16	38	388	7.6	2949	9.5	3686	11.4	4423	12.5	4850	
R 32 - 044			44	324	8.8	2851	11.0	3564	13.2	4277	14.9	4828	
R 32 - 051			51	272	10.2	2774	12.8	3482	15.3	4162	17.8	4842	
R 32 - 064			64	212	12.8	2714	16.0	3392	19.2	4070	22.4	4749	
R 32 - 076			76	172	15.2	2614	19.0	3268	22.8	3922	26.1	4489	
R 32 - 089			89	141	17.8	2510	22.3	3144	26.7	3765	30.8	4343	
R 32 - 102			102	122	20.4	2489	25.5	3111	30.6	3733	36.8	4490	
R 32 - 115			115	107	23.0	2461	28.8	3082	34.5	3692	41.4	4430	
R 32 - 127			127	93.0	25.4	2362	31.8	2957	38.1	3543	44.4	4129	
R 32 - 139			139	86.0	28.0	2408	35.0	3010	42.0	3612	48.5	4171	
R 32 - 152			152	78.0	30.4	2371	38.0	2964	45.6	3557	54.8	4274	
R 32 - 178			178	67.2	35.6	2392	44.5	2990	53.4	3588	63.6	4274	
R 32 - 203			203	59.1	40.6	2399	50.8	3002	60.9	3599	72.5	4285	
R 32 - 254			254	46.4	50.8	2357	63.5	2946	76.2	3536	92.8	4306	
R 32 - 305			7.1x5.4	305	38.0	61.0	2318	76.3	2899	91.5	3477	111.8	4248
R 40 - 051	40	20	51	350	10.2	3570	12.8	4480	15.3	5355	17.0	5950	
R 40 - 064			64	269	12.8	3443	16.0	4304	19.2	5165	21.9	5891	
R 40 - 076			76	219	15.2	3329	19.0	4161	22.8	4993	26.7	5847	
R 40 - 089			89	190	17.8	3382	22.3	4237	26.7	5073	31.3	5947	
R 40 - 102			102	163	20.4	3325	25.5	4157	30.6	4988	37.1	6047	
R 40 - 115			115	142	23.0	3266	28.8	4090	34.5	4899	41.0	5822	
R 40 - 127			127	128	25.4	3251	31.8	4070	38.1	4877	46.5	5952	
R 40 - 139			139	115	28.0	3220	35.0	4025	42.0	4830	53.1	6107	
R 40 - 152			152	105	30.4	3192	38.0	3990	45.6	4788	56.1	5891	
R 40 - 178			178	89	35.6	3168	44.5	3961	53.4	4753	67.4	5999	
R 40 - 203			203	77	40.6	3126	50.8	3912	60.9	4689	76.2	5867	
R 40 - 254			254	61	50.8	3099	63.5	3874	76.2	4648	96.2	5868	
R 40 - 305			8.4x6.2	305	51	61.0	3111	76.3	3891	91.5	4667	114.8	5855



PRODUKT GROUP s.r.o.

Jánošíkova 560

906 32 Jablonica

IČO: 47723254

DIČ: 2024064031

IČ DPH: SK2024064031

+421 910 397 780

+421 34 65 83 401

info@pruziny.com

www.pruziny.com

Pružiny do nástrojov a foriem podľa DIN 10243 – NP-R

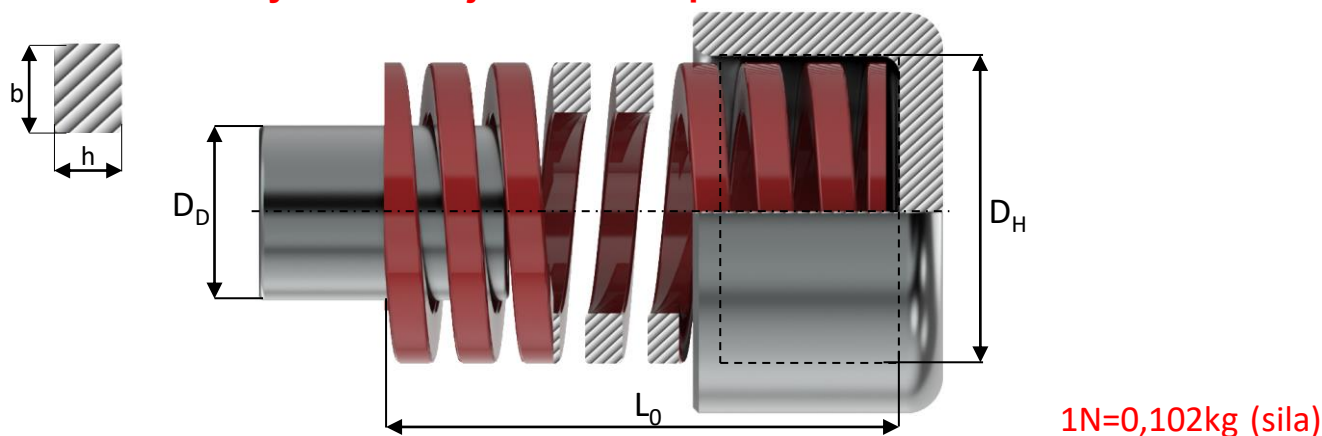

KATALÓGOVÉ ČÍSLO	D _H D _D		L ₀	Tuhosť k	20%		25%		30% Max. dovolené stlačenie		D Max. stlačenie	
	bxh											
	mm	mm										mm
R 50 - 064	50	25	64	413	12.8	5286	16.0	6608	19.2	7930	22.4	9251
R 50 - 076			76	339	15.2	5153	19.0	6441	22.8	7729	26.5	8984
R 50 - 089			89	288	17.8	5126	22.3	6422	26.7	7690	31.5	9072
R 50 - 102			102	245	20.4	4998	25.5	6248	30.6	7497	37.6	9212
R 50 - 115			115	215	23.0	4945	28.8	6192	34.5	7418	42.7	9181
R 50 - 127			127	192	25.4	4877	31.8	6106	38.1	7315	47.5	9120
R 50 - 139			139	168	28.0	4704	35.0	5880	42.0	7056	51.8	8702
R 50 - 152			152	154	30.4	4682	38.0	5852	45.6	7022	57.8	8901
R 50 - 178			178	134	35.6	4770	44.5	5963	53.4	7156	68.5	9179
R 50 - 203			203	117	40.6	4750	50.8	5944	60.9	7125	77.6	9079
R 50 - 254			254	89	50.8	4521	63.5	5652	76.2	6782	97.9	8713
R 50 - 305			11.1x7.6	305	73	61.0	4453	76.3	5570	91.5	6680	120.7
R 63 - 076	63	38	76	618	15.2	9394	19.0	11742	22.8	14090	24.7	15265
R 63 - 089			89	515	17.8	9167	22.3	11485	26.7	13751	30.0	15450
R 63 - 102			102	438	20.4	8935	25.5	11169	30.6	13403	35.1	15374
R 63 - 115			115	370	23.0	8510	28.8	10656	34.5	12765	37.5	13875
R 63 - 127			127	333	25.4	8458	31.8	10589	38.1	12687	45.9	15285
R 63 - 152			152	269	30.4	8178	38.0	10222	45.6	12266	56.5	15199
R 63 - 178			178	226	35.6	8046	44.5	10057	53.4	12068	66.8	15097
R 63 - 203			203	198	40.6	8039	50.8	10058	60.9	12058	78.8	15602
R 63 - 254			254	155	50.8	7874	63.5	9843	76.2	11811	101.7	15763
R 63 - 305			11.6x12.3	305	128	61.0	7808	76.3	9766	91.5	11712	122.4



PRODUKT GROUP s.r.o.

Jánošíkova 560

906 32 Jablonica

IČO: 47723254

DIČ: 2024064031

IČ DPH: SK2024064031

+421 910 397 780

+421 34 65 83 401

info@pruziny.com

www.pruziny.com